

# CRYSTAL DISPLAY SYSTEMS LTD

Stretch BAR / Panoramic & Square Display Solutions

CDS  
Crystal Display Systems Ltd

StretchedVUE

SquareVUE



# What is a stretched display?



↓ **16:9 ratio** ↓  
**Quarter cut to**  
**16:2.25 ratio**



**MORE INFO**



Traditional mass produced LCD displays have of a width/height ratio which generally follows industrial or consumer volume demand. This is normally widescreen 16:9 ratio (Like a TV or desktop monitor) or square 4:3 ratio (original 1980's desktop monitor or industrial small format)

Stretch or 'panoramic' displays is a range from CDS which do not follow these normal ratio's, allowing for niche solutions and application where a display would not mechanically fit and not normally be an option.

The original display is very precisely cut in a controlled environment changing the ratio \*1

For the stretch it is common to cut from larger format 16:9 panels (this gives most options). Preferred cuts are; half cut giving 16:4.5 (e.g. 1920x540px or 3840x1080px), a third cut (e.g. 1920x360px) or a quarter cut (e.g. 1920x270px or 3840x540px)

CDS also offer even narrow display for shelf edge applications or complete BESPOKE, so if a size is not list you can contact us

*\*1 - CDS have a number of native panoramic solutions available*

# ***Applications are Suitable for Stretched Bar Type Displays?***

Stretched Displays are ideal for applications such as transportation signage, retail shelving, menu boards, and industrial instrumentation where space constraints or unique design requirements exist.

New applications show an increasing number of case studies and references.

**LEARN MORE**



CDS also has an increasing number of virtual demonstrations showing the actual product with current CDS staff.

## **Virtual 77" Demonstration**



# STRETCH SCREEN SPECIFICATIONS

Model Number	Diagonal	Pixels	Ratio	Brightness	Active area	Overall size	Notes	Drawing
MO-192-001-EW-500-Z	19.2"	1920x360	16:3	500nits	478x91mm	499x115x41mm		<a href="#">CONTACT</a>
MO-239-002-EW-700-Z	23.9"	1920x360	16:3	700nits	598x112 mm	626.1x142.6x65mm		<a href="#">CONTACT</a>
MO-290-002-EW-700-Z	29.0"	1920x540	16:4.5	700nits	706x198mm	724x229x68mm		»
MO-368-002-EW-1000-Z	36.8"	1920x358	16:3	1000nits	919x172mm	963x172x70mm		»
MO-370-002-EW-700-Z	37.0"	1920x540	16:4.5	700nits	900x253mm	918x284x70mm		<a href="#">CONTACT</a>
MO-424-001-EW-1000-Z	42.4"	1920x143	16:1.19	1000nits	1074x80mm	1141x149x63mm	12vdc I/P, with flanges	»
MO-435-002-EW-1000-Z	43.5"	1920x268	16:2.25	1000nits	1096x153mm	1125x188x67mm		»
MP-470-001-EW-500-Z	47.0"	3840x160	16:0.67	500nits	1196x50mm	1212x66x67mm	Android board	<a href="#">CONTACT</a>
MO-495-004-EW-800-Z	49.5"	3840x1080	16:4.5	800nits	1209x340mm	1244x374x66mm		»
MO-584-003-EW-800-Z	58.4"	3840x1080	16:4.5	800nits	1428x402mm	1474x447x72mm		»
MO-775-001-EW-700-Z	77.5"	3840x1080	16:4.5	700nits	1895x533mm	1929x567x72mm		»

OTHER SIZES AVAILABLE - CONTACT CDS IF YOU YOUR REQUIRED SIZE IS NOT LISTED

## FEATURES & OPTIONS

- HIGH BRIGHT
- PCAP / IR touchscreens
- FULL bespoke design
- Custom sizes and Cuts
- HDMI / PC / Android interface

## RATIO GUIDES

- » HALF CUT (16:4.5)
- » THIRD CUT (16:3)
- » ULTRA STRETCH CUT
- » SQUARE DISPLAYS



- PRICING
- LEADTIMES
- FULL SPECS INCL CAD / STP FILES
- DESIGN SUPPORT

# Third Cut Stretch displays

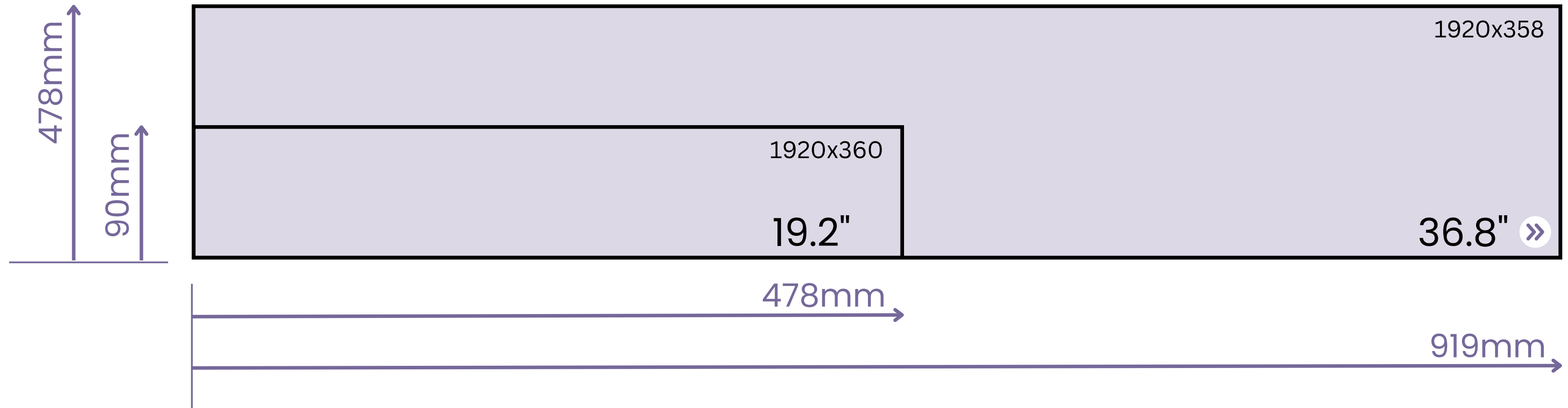

# Half Cut Stretch displays ~ the most popular range

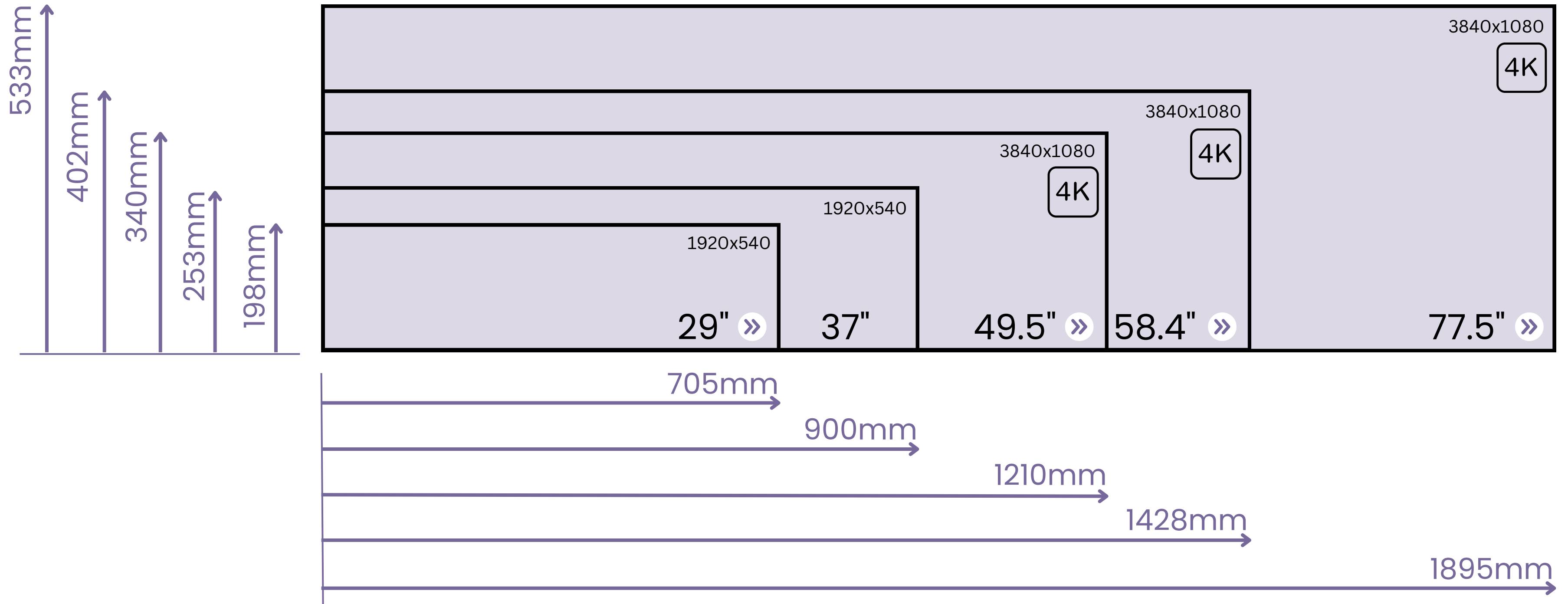

# Ultra-thin Cut Stretch displays

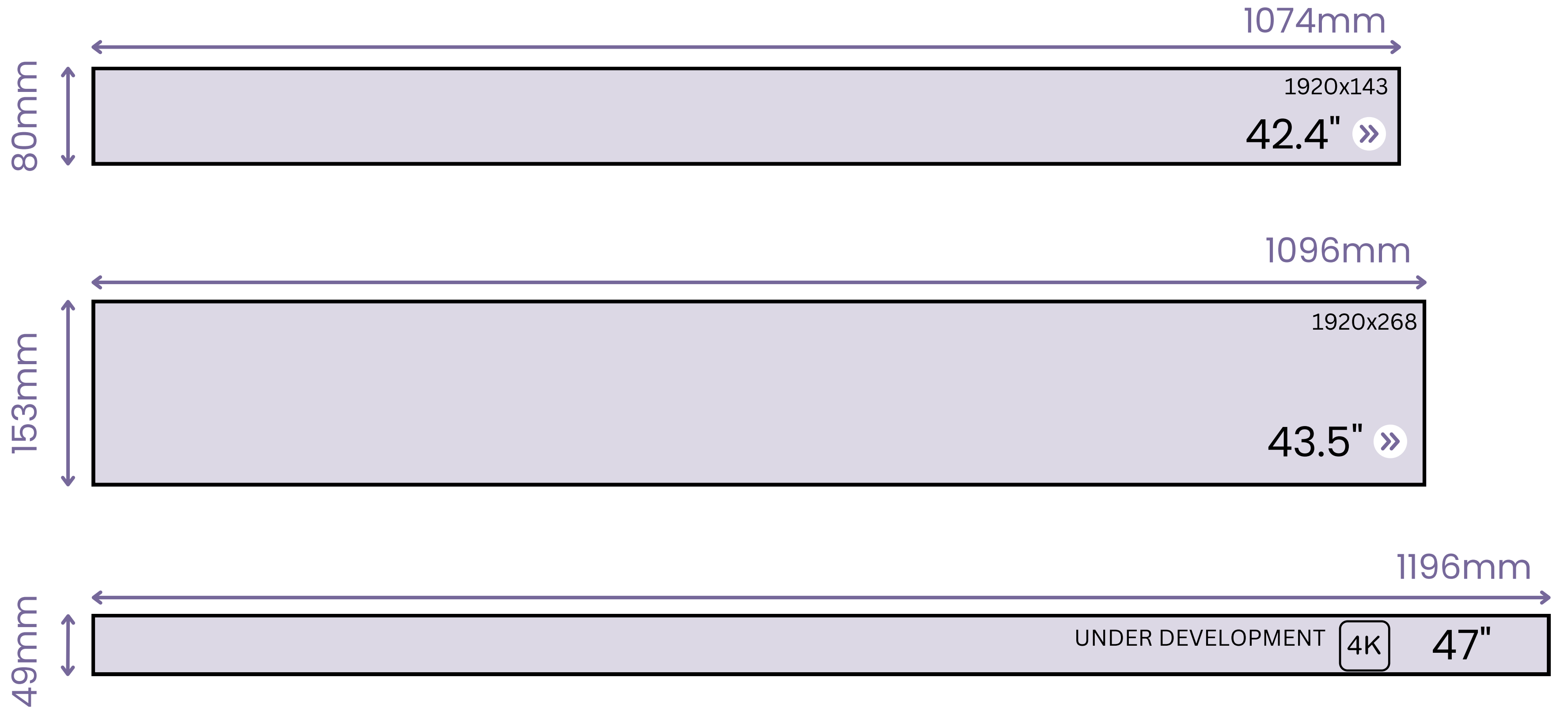

# ALSO try our square 'Quadrate' displays

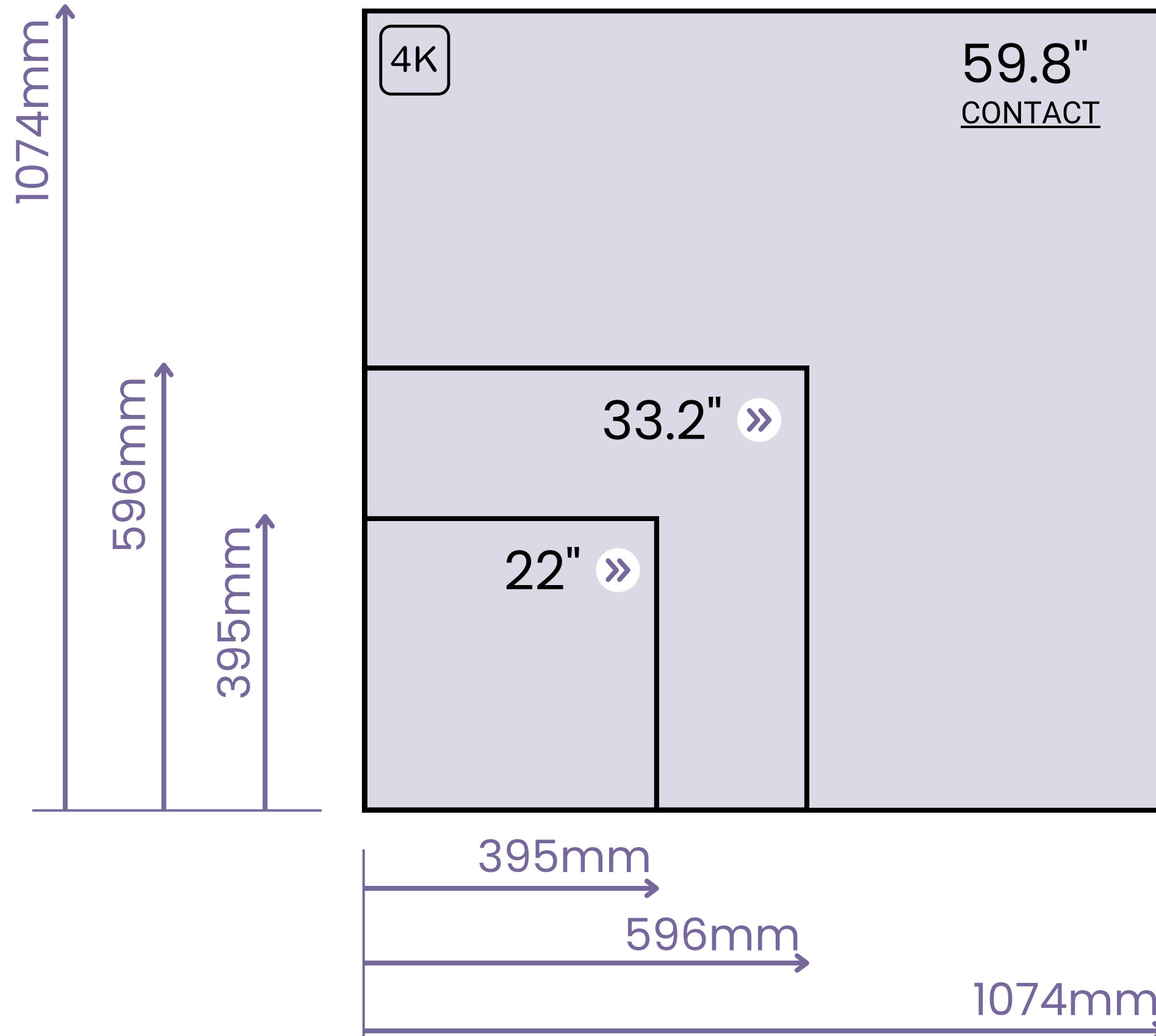



## FEATURES

- Resizing LCD 29" diagonal
- Ultra Wide 1920x358
- 700cd, 178/178 viewing angle
- HDMI x 1
- USB Multimedia playback

## MO-290-002-EW-700-Z

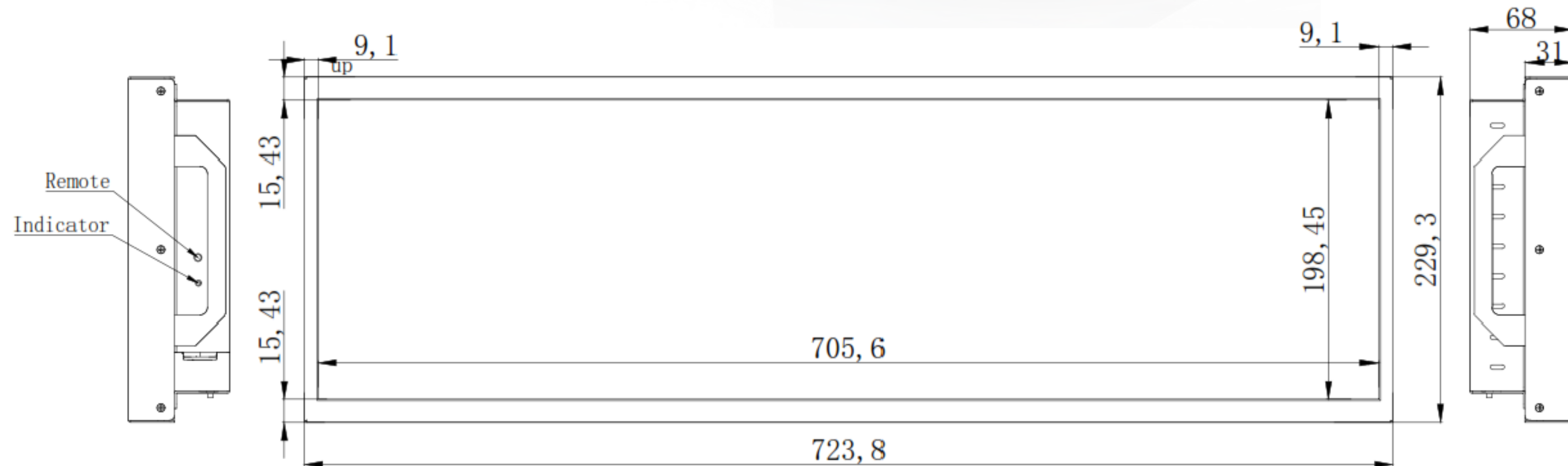

## FEATURES

- Resizing LCD 36.8" diagonal
- Ultra Wide 1920x358
- High Bright 1000cd,
- 178/178 viewing angle
- HDMI x 2 ~ DP x 1
- USB Multimedia playback

# MO-368-002-EW-1000-Z

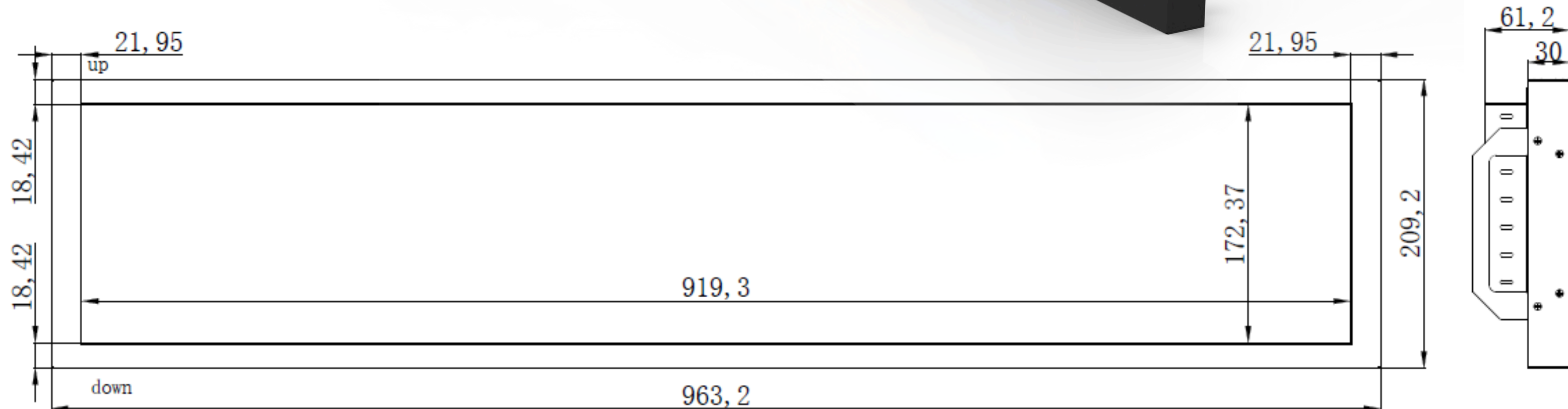

## FEATURES

- Resizing LCD 42.5" diagonal
- Ultra Wide 1920x143
- High Bright 1000cd,
- 178/178 viewing angle
- HDMI x 1
- USB Multimedia playback

## MO-424-001-EW-1000-Z

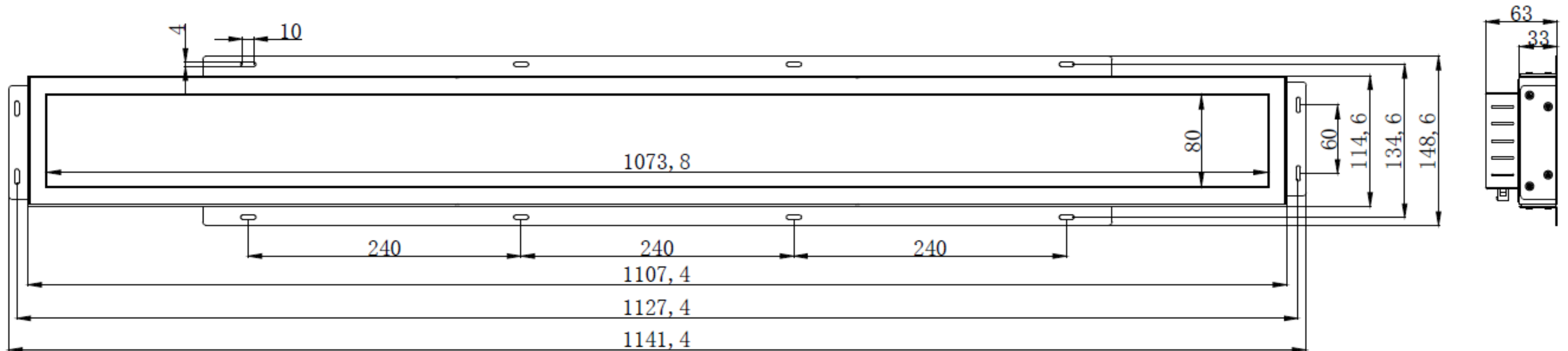

## FEATURES

- Resizing LCD 43.5" diagonal
- Ultra Wide 1920x268
- High Bright 1000cd,
- 178/178 viewing angle
- HDMI x 1 ~ DP x 1
- USB Multimedia playback

# MO-435-002-EW-1000-Z

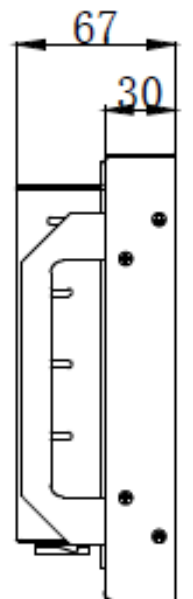
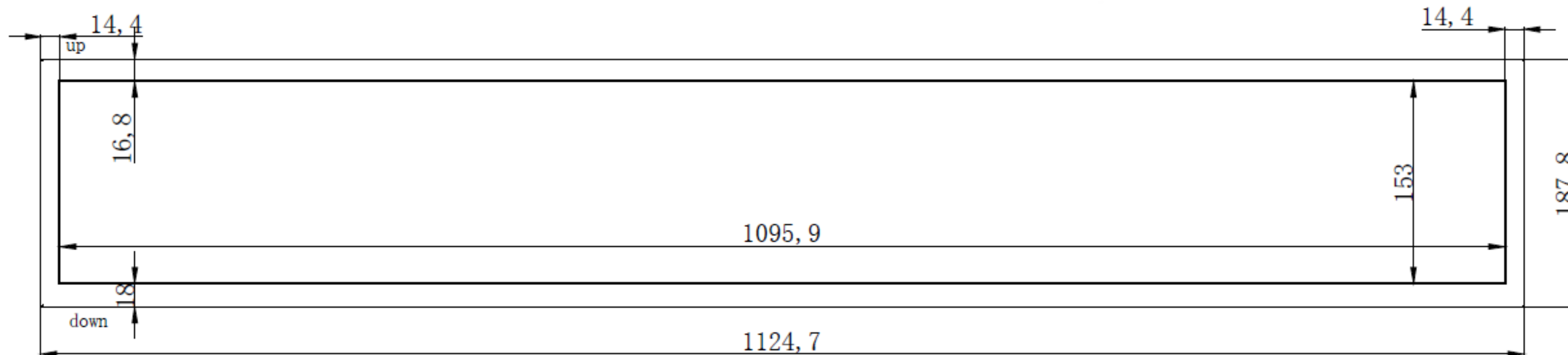

## FEATURES

- Resizing LCD 49.5" diagonal
- Ultra Wide 3840x1080
- 800cd, 178/178 viewing angle
- HDMI x 1 ~ DP x 1

# MO-495-004-EW-800-Z

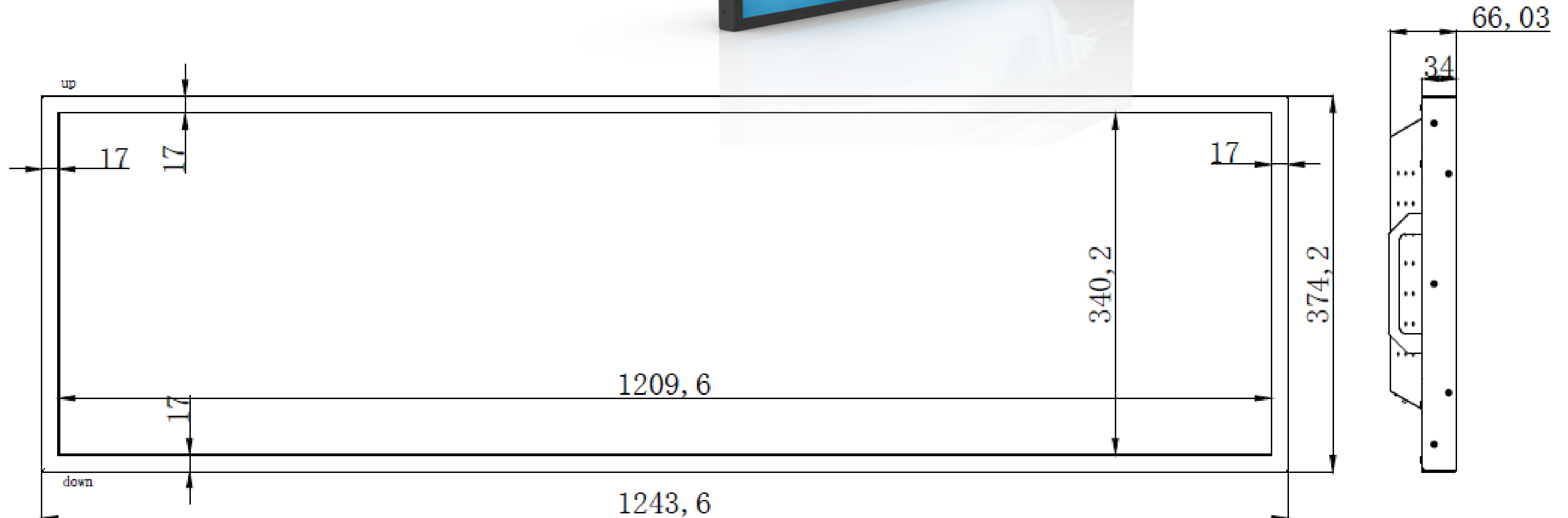

## FEATURES

- Resizing LCD 58.4" diagonal
- Ultra Wide 3840x1080
- 800cd, 178/178 viewing angle
- HDMI x 1 ~ DP x 1

# MO-584-003-EW-800-Z

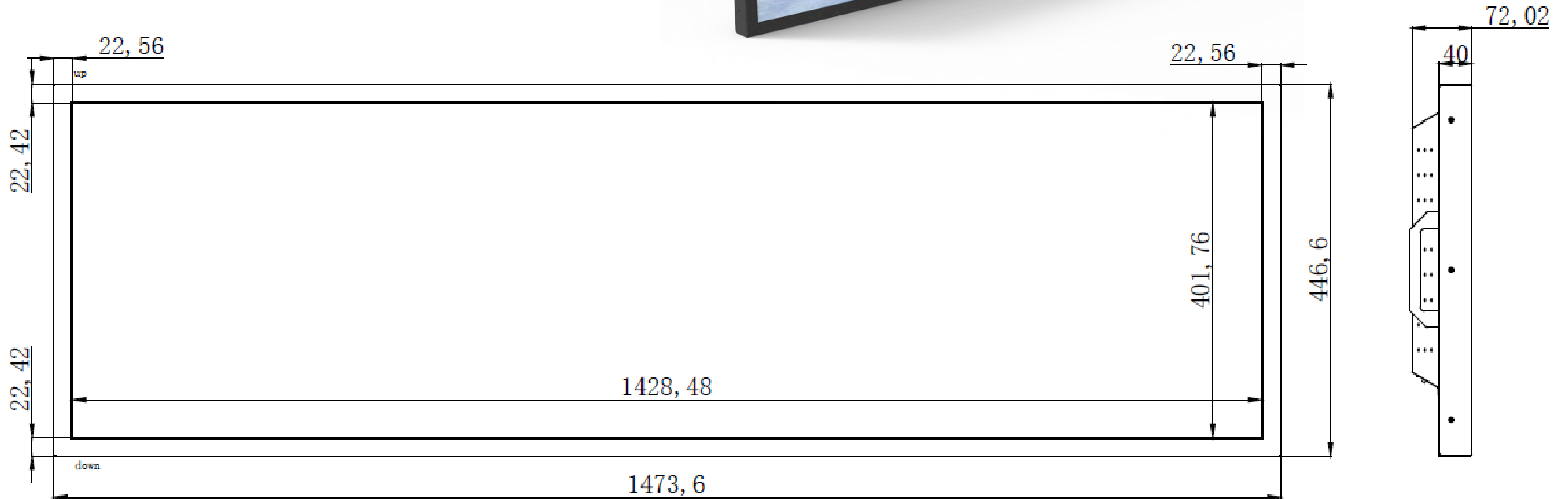

## FEATURES

- Resizing LCD 77.5" diagonal
- Ultra Wide 3840x1080
- 700cd, 178/178 viewing angle
- HDMI x 1 ~ DP x 1

# MO-775-001-EW4K-700-Z

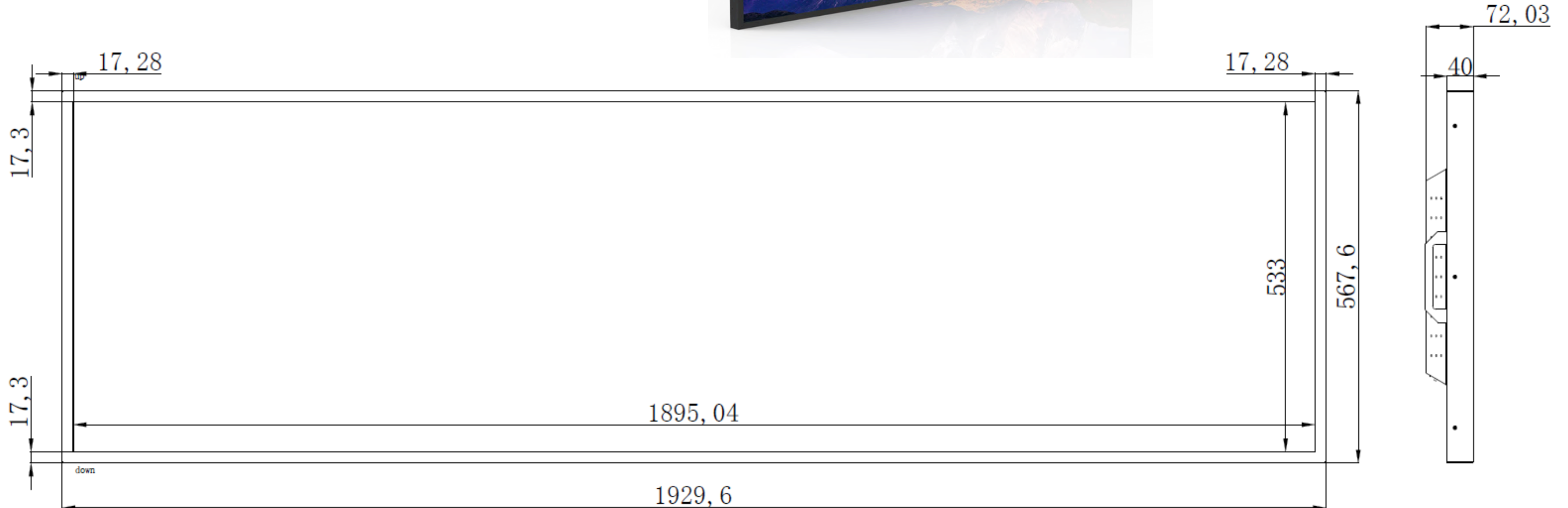

## FEATURES

- Square LCD 22" diagonal
- 1920x1920
- 500cd, 178/178 viewing angle
- HDMI ~ DVI ~ DP



# MO-220-004V2-SQ-500-Z

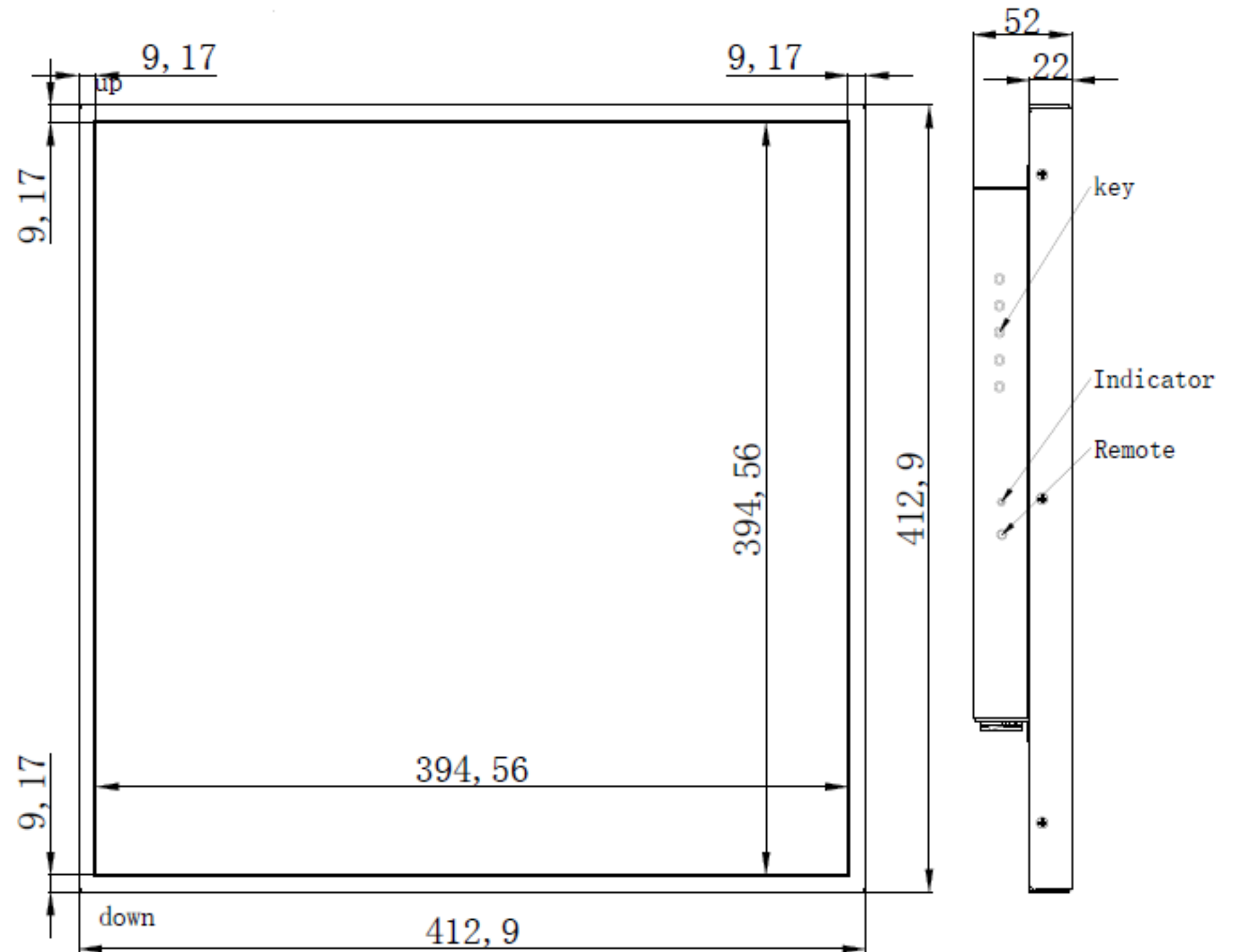



## FEATURES

- Square LCD 33.2" diagonal
- 1920x1920
- 500cd
- 178/178 viewing angle
- HDMI x 2 ~ DP
- PCAP TOUCH version



# MO-332-002-SQ-500-V

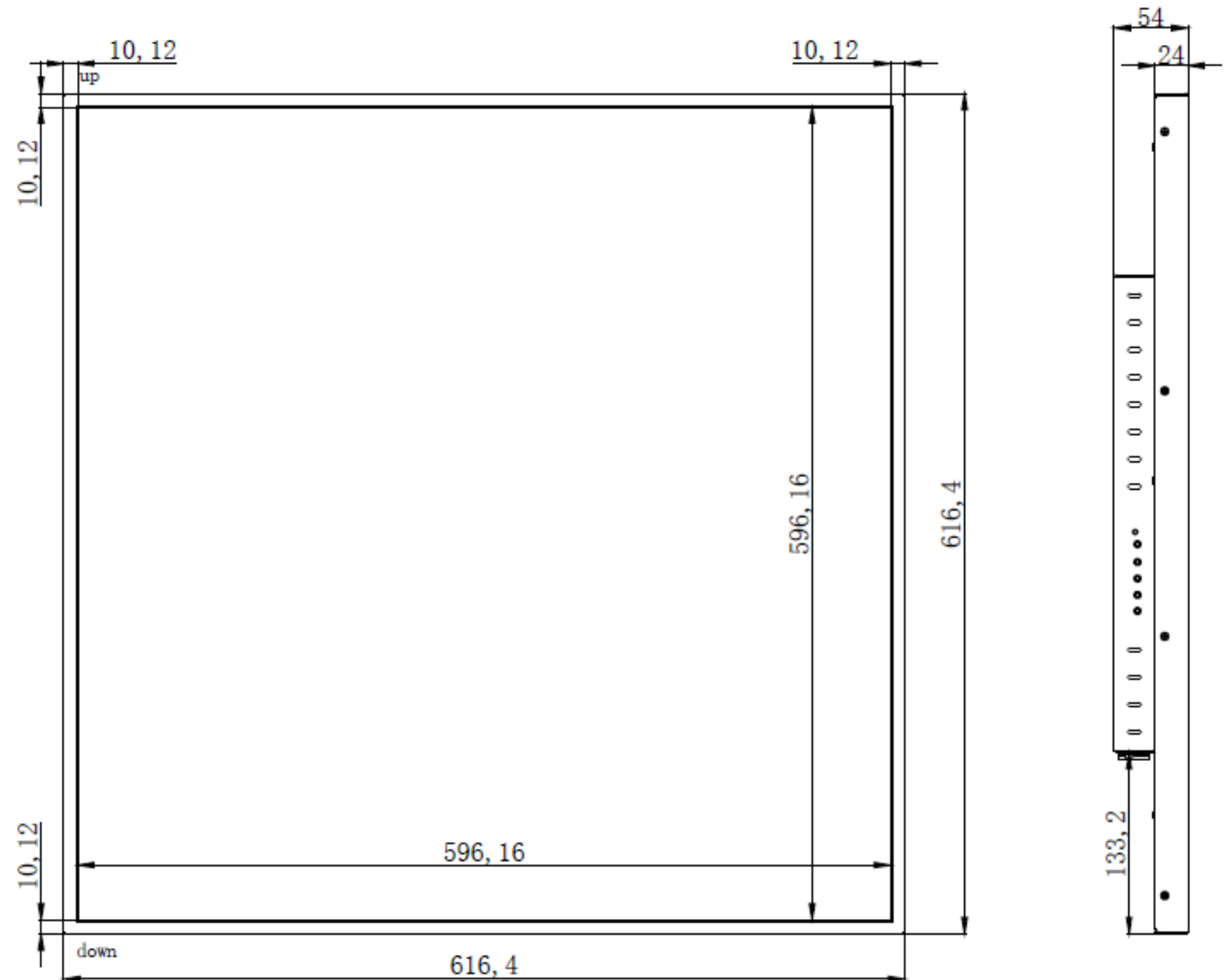

# Crystal display systems - About us!

**The CDS Philosophy of business** – Industrial Displays from Crystal Display Systems the leading designer, distributor, value added reseller as well as the developer of custom monitors and customization of flat panel display solutions.

Established over 12 years ago, our expertise allows us to offer the best solutions to our clients and partners. We offer Industrial TFT LCDs, OLEDs embedded AIO, touch screens, and digital signage solutions.

With the CDS philosophy of business we combine the latest industrial and retail displays and technology, engineering and manufacturing capabilities to optimise our integrated solutions.

If you have a requirement for any digital display products then please contact our Technical sales and support team to work closely with you on your specific project and requirements.

---

## DOWNLOAD CENTRE

<https://crystal-display.com/cds-presentation-download/>

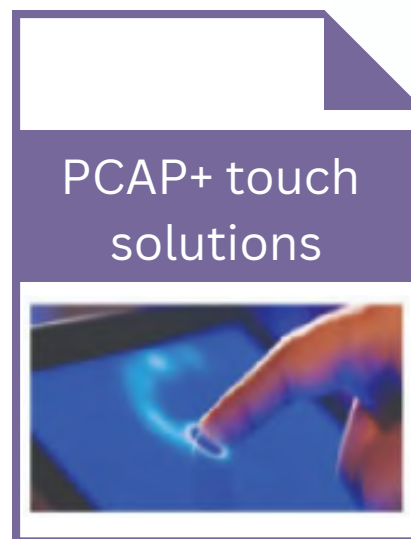
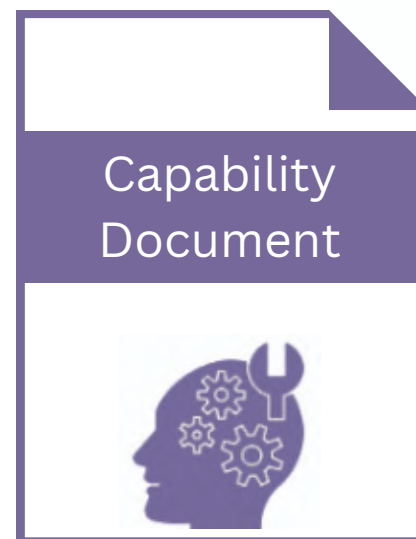



E&OE

Need any additional information?

Our team is always available to help you with pricing details, technical support, or any additional information you may need. Please don't hesitate to reach out.



CONTACT US



Crystal Display Systems Ltd  
Unit 6 M2M Park, Fort Bridgewood  
Maidstone Road, Rochester,  
Kent. ME1 3DQ

T : +44(0) 1634 791600

E : [info@crystal-display.com](mailto:info@crystal-display.com)

W : [crystal-display.com](http://crystal-display.com)

SPECIALIST GLOBAL SUPPLIERS IN INNOVATIVE LCD  
DISPLAY, TOUCH AND DIGITAL SIGNAGE SOLUTIONS